



The Sound That Will *Move* You

# MINIME FF8<sub>v2</sub> USER MANUAL



## Table of Contents

About Earthquake Sound Corporation.....	3
Safety Instructions.....	4 - 5
Introduction.....	6
What Makes a MiniMe?.....	6
Control Panel Overview.....	7 - 8
Placing Your Subwoofer(s).....	9
Connecting Your Subwoofer(s).....	10 - 13
Adjusting Your Subwoofer(s).....	14
Dimensions and Specifications.....	15
Warranty Information.....	16 - 17
For Your Records.....	18



**The Sound That Will Move You**

Earthquake Sound Corporation  
2727 McCone Avenue  
Hayward, CA 94545  
United States of America  
Tel: 510-732-1000  
Fax: 510-732-1095



**WARNING:** This product is capable of generating high sound pressure levels. You should exercise caution when operating these speakers. Long term exposures to high levels of sound pressure will cause permanent damage to your hearing. Sound pressure levels exceeding 85dB can be dangerous with constant exposure, set your audio system to a comfortable loudness level. Earthquake Sound Corporation does not assume liability for damages resulting from the direct use of Earthquake Sound audio product(s) and urges users to play volume at moderate levels.

© 2014 Earthquake Sound Corporation. All rights reserved.  
This document should not be construed as a commitment on the part of Earthquake Sound Corporation.  
The information is subject to change without notice.  
Earthquake Sound Corporation assumes no responsibility for errors that may appear within this document.

## About Earthquake Sound Corporation

For over 28 years, Earthquake Sound has been producing a variety of high quality audio products that have impressed audiophile communities around the world. It all started in 1984 when Joseph Sahyoun, a music freak and Aerospace Engineer unhappy with the existing loud speaker technology and performance, decided to put his advance engineering knowledge to use. He pushed technological boundaries to the limit to create the kind of subwoofer he could live with. Earthquake quickly created a name for itself in the car audio industry and became well known for its powerful subwoofers and amplifiers. In 1997, using his existing expertise in the audio industry, Joseph Sahyoun expanded his company to home audio production.

Earthquake Sound has since evolved into a leader in the home audio industry, producing not only subwoofers and amplifiers but surround speakers and tactile transducers as well. Engineered by audiophiles for audiophiles, Earthquake Sound audio products are meticulously crafted to reproduce each and every single note perfectly, bringing your home theater experience to life. With true dedication and full attention to details, Earthquake Sound engineers continuously develop new and better products to meet customers' needs and go beyond their expectations.

From mobile audio to prosound and home audio, Earthquake Sound has been selected as the winner of many prestigious awards based on sound quality, performance, value and features. CEA and numerous publications have awarded Earthquake Sound with over a dozen design and engineering awards. Additionally, Earthquake Sound has been granted many design patents by the USPO for revolutionary audio designs that have changed the sound of the audio industry.

Headquartered in a 60,000 square foot facility in Hayward, California USA, Earthquake Sound currently exports to over 60 countries worldwide. In 2010, Earthquake Sound expanded its export operations by opening a European warehouse in Denmark. This accomplishment was recognized by the US Department of Commerce who honored Earthquake Sound with an Export Achievement award at the 2011 Consumer Electronic Show. Just recently, the US Department of Commerce presented Earthquake Sound with another Export Achievement award for expanding its export operations in China.

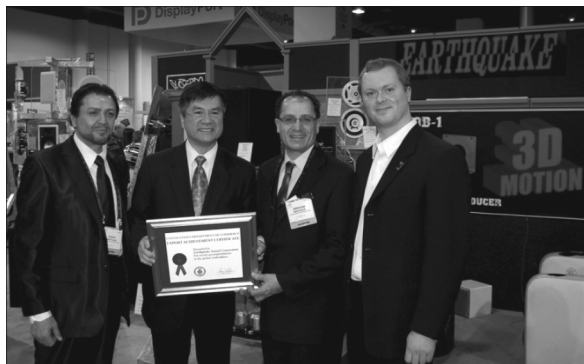

Joseph Sahyoun, US Secretary of Commerce Gary Locke, Abraham Sahyoun and Thomas Mygind



US Commercial Officer Sarah Fox and Joseph Sahyoun

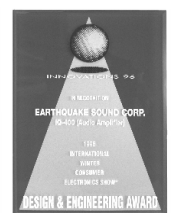
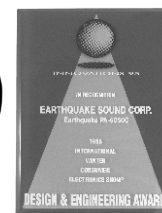
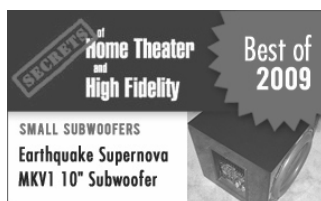

# Safety Instructions

## Safety First

This documentation contains general safety, installation, and operating instructions for the MiniMe FF8v2 subwoofer. It is important to read this user's manual before attempting to use this product. Pay particular attention to the safety instructions.

## Symbols Explained:



Appears on the component to indicate the presence of uninsulated, dangerous voltage inside the enclosure – voltage that may be sufficient to constitute a risk of shock.

### CAUTION

Calls attention to a procedure, practice, condition or the like that, if not correctly performed or adhered to, could result in injury or death.

### WARNING

Calls attention to a procedure, practice, condition or the like that, if not correctly performed or adhered to, could result in damage to or destruction of part or all of the product.

### NOTE:

Calls attention to information that is essential to highlight.

## Important Safety Instructions:

- 1) Read these instructions in their entirety.
- 2) Store this manual and packaging in a safe place.
- 3) Heed all warnings.
- 4) Follow instructions (do not take shortcuts).
- 5) Do not use this apparatus near water.
- 6) Clean only with a dry cloth.
- 7) Do not block any ventilation openings. Install in accordance with the manufacturer's instructions.
- 8) Do not install near any heat sources such as radiators, heat registers, stoves, or other apparatuses that produce heat.
- 9) Do not defeat the safety purpose of the polarized or grounding-type plug. A polarized plug has two blades with one wider than the other. The grounding-type plug has two blades and a third grounding prong. The wide blade or the third prong is provided for your safety. If the provided plug does not fit into your outlet, consult an electrician for replacement of the obsolete outlet.
- 10) Protect the power cord from being walked on or pinched, particularly at plugs, convenience receptacles, and the point where they exit from the apparatus.
- 11) Only use attachments and accessories specified by the manufacturer.
- 12) Use only a compatible rack or cart for the final resting position.
- 13) Unplug this apparatus during lightning storms or when unused for a long period of time.
- 14) Refer all servicing to qualified service personnel. Servicing is required when the apparatus has been damaged in a way such as: power-supply cord or plug is damaged, liquid has been spilled or objects have fallen into the apparatus, the apparatus has been exposed to rain or moisture, does not operate normally, or has been dropped.
- 15) To reduce the risk of fire or electric shock, do not expose this apparatus to rain or moisture.

## System Installation Considerations

There are several factors to consider before installing Earthquake Sound's MiniMe FF8v2 Subwoofer.

- What are the intended listening zones?
- From where in each zone will the listener prefer to control the system? Where will the subwoofer be located?
- Where will the source equipment be located?

## Connection Tips

- Keep all power cords away from all signal cables to prevent humming from induced noise.
- Choose reliable signal cable cords (Earthquake Sound also specializes in high performance RCA cables and patches).
- All speaker wires that are ran through the walls should be twisted type to reduce potential hum noise pick-up.
- It is best to use a grounded electrical outlet to power the amplifier. Lack of input ground reference could be unsafe. Consult with your electrical contractor about proper grounding.

## Safe & Proper handling

The MiniMe FF8v2 subwoofer is considerably light weight and easy to maneuver. However, we encourage you to take precaution when unpacking the unit to prevent any possible damage to your MiniMe FF8v2. We further suggest the following:

- Do not apply pressure or push against the face of the speaker as this will cause irreparable damage to the cone and suspension.
- When carrying the MiniMe FF8v2, make sure that the speakers/grilles are away from your chest, eliminating the chance of pushing against the face of the speaker.
- Do not drop the MiniMe FF8v2 or subject it to sudden shocks. This will damage the external finish and weaken the enclosure, creating air leaks.
- Avoid exposing the MiniMe FF8v2 to moisture. Water will damage the structure as well as the amplifier and speakers.
- Cleaning the MiniMe FF8v2 is best done using soft cloth. If needed, use mild detergent with water. Like any other electrical unit, always unplug the unit before cleaning it.

## Unpacking the MiniMe FF8v2

- Keep the original carton and packing materials for future shipment or storage.
- Check for any visual signs of damage. If you encounter any concealed damage, consult your Earthquake Sound dealer before proceeding with unit installation.
- Retain the sales receipt as it establishes the duration of the limited warranty and provides information for insurance purposes.

The MiniMe is packaged well for safety. We highly suggest having a padded surface when unpacking it.

### **Step 1:**

On a padded surface, carefully place the box on its side to remove the bottom packing tape and staples.

### **Step 2:**

Without tilting the box too much, tug the bottom flaps outward and keep the protective foam in place.



### **Step 3:**

Gently reposition the box upright.



### **Step 4:**

Slide the box off, minding the protective foam on the top, bottom and sides of the subwoofer.

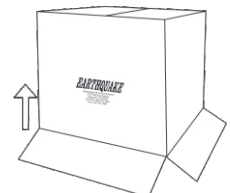
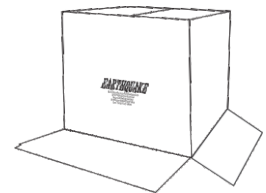

This triangle, which appears on your component, alerts you to the presence of uninsulated, dangerous voltage inside the enclosure - voltage that may be sufficient to constitute a risk of shock.

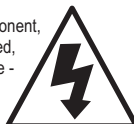

This triangle, which appears on your component, alerts you to important operating and maintenance instructions in this accompanying literature.





## Introduction

The MiniMe system is designed to dramatically enhance your enjoyment of music and films at home by adding power and impact to low frequency sound effects without taking up your entire living space. Congratulations and thank you for choosing the Earthquake MiniMe FF8<sub>v2</sub> subwoofer as a key component of your audiophile system.

The MiniMe FF8<sub>v2</sub> subwoofer utilizes an advanced digital class “D” amplifier and an 8” premium long throw driver. With a sealed design and front firing piano gloss enclosure, it can be placed in tight spaces where non-front firing subs cannot fit.

Designed in the USA, the MiniMe FF8<sub>v2</sub> Subwoofer meets and exceeds all industry standards of performance and quality. With uncompromised “World Class” performance and superior technology, the MiniMe FF8<sub>v2</sub> subwoofer embodies both power and elegance.

## What Makes a MiniMe?

### Digital Class “D” Amplifier



The MiniMe FF8<sub>v2</sub> amplifier utilizes the advanced class “D” circuitry with over 90% efficiency, allowing it to continuously perform without getting hot.

The 320-Watt peak power amplifier is fully equipped with 50 - 160Hz frequency adjustment control, 0 - 180°

phase adjustment, low level RCA input, auto signal sensing, as well as high level speaker inputs and outputs.

### Luxurious Piano Gloss Cabinet



The deep luxurious black piano lacquer begins with a thorough sanding and priming, followed by multiple applications of black lacquer with additional fine sanding between each layer, and finished with a smooth, high gloss clear coat.

When it comes to elegance and style, the MiniMe FF8<sub>v2</sub> delivers.

### Premium Long Throw Drivers



The active driver installed in every MiniMe FF8<sub>v2</sub> is specifically designed for accurate reproduction of bass and sub-bass frequencies.

Built with TCT (Turbine Cooled Transducer) Technology, stitched tensile leads, anti-

wobble cone construction and reinforced dust cap, the MiniMe FF8<sub>v2</sub> driver effortlessly produces phenomenal bass with extremely low distortion while staying cool the entire time.

# Control Panel Overview

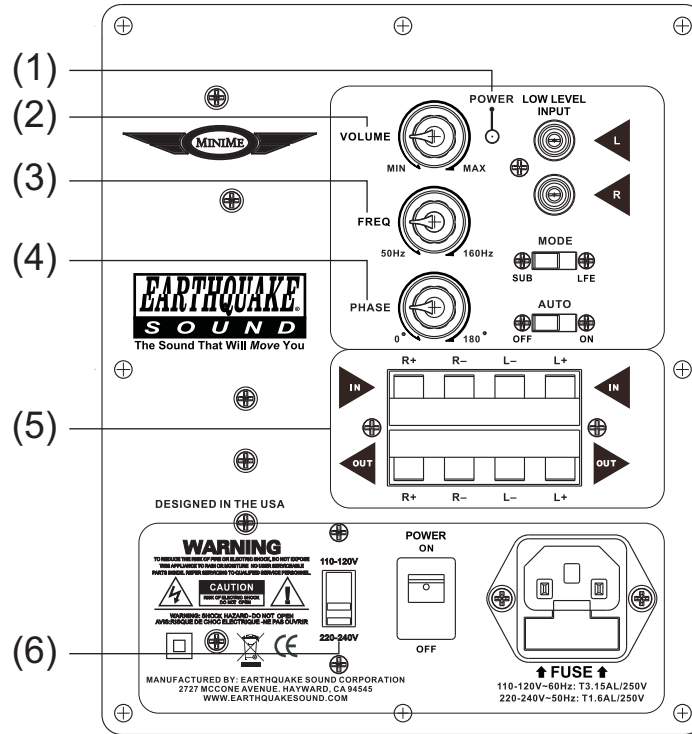

## (1) LED Power Signal Indicator

This LED indicator reflects the main power status of the amplifier as well as the state of the amplifier (whether the AUTO Sensing is on/off and whether signal is being fed to the amplifier). Note that this LED will only light up when the main power switch is in the ON position.

Signal Sensing	Is there signal?	LED Color
ON	Yes	Green
	No	Green
AUTO	Yes	Green
	No	Red
OFF	Yes	Red
	No	Red

## (2) Volume Control

This knob allows the user to control the volume of the subwoofer. Always start at the lowest setting and slowly increase the volume until the desired subwoofer level is reached.

## (3) 50-160Hz Frequency Adjustment

This knob allows user to set the subwoofer's cut off frequency. Signals above the set crossover frequency will be gradually rolled off to prevent them from interfering with the surround speakers.

## (4) 0-180° Phase Adjustment

This 0° - 180° switch allows user to synchronize the subwoofer to obtain better and more precise bass response.

## (5) High Level Inputs / Outputs

These clamp style input terminals allows the MiniMe FF8v2 amplifier to receive signal from the amplifier or receiver that is powering the surround speakers. The output terminals allows the MiniMe FF8v2 to drive stereo satellite speakers.

### NOTE:

**DO NOT USE HIGH LEVEL AND LOW LEVEL INPUTS AT THE SAME TIME.**

## (6) 110V/220V AC Selector

The MiniMe FF8v2 can operate in a 110-120V or 220-240V environment. Simply slide the selector to the required power setting and replace the fuse to the proper rating prior to connecting the subwoofer to a power source.

## Control Panel Overview continued

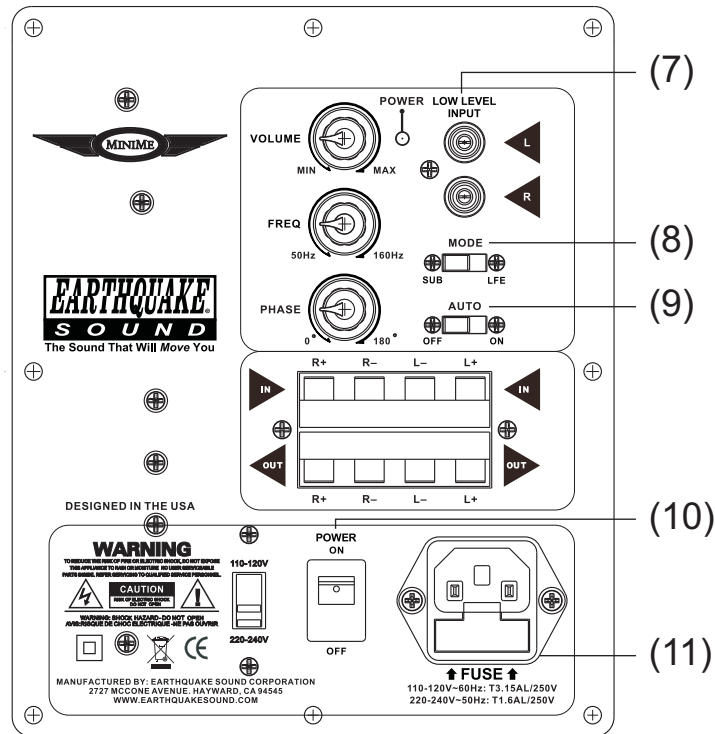

### (7) Low Level RCA Inputs

This is the best way to drive audio signal to the MiniMe FF8v2.

#### NOTE:

**DO NOT USE HIGH LEVEL AND LOW LEVEL INPUTS AT THE SAME TIME**

### (8) LFE/SUB Operation Mode Switch

When the switch is in LFE position, the subwoofer is running in full range mode (20Hz - 2kHz) and the frequency adjustment is disabled. When the switch is in SUB position, the subwoofer reverts to manual frequency adjustment, allowing the user to operate and fine tune the subwoofer to his/her preference.

### (9) AUTO/ON/OFF Switch

This is a 3-way switch. When ON, the amplifier will remain on regardless of signal presence. When set to AUTO, the amplifier will only turn on when audio signal is detected. Additionally, the amplifier will go to sleep/stand-by if it does not detect any signal after 15 minutes. When set to OFF, the amplifier will remain off regardless of signal presence. Note that the

MAIN POWER switch must be ON for this feature to work.

### (10) Main Power Switch

When switched OFF, the amplifier will remain off as there is no AC power being fed into it. We highly recommend keeping this switch OFF when the subwoofer is not being used for an extended period of time.

### (11) AC Power with Built-in Fuse

This AC line connector is fused to protect the subwoofer from unwanted power surges. Be sure to use the proper fuse rating when replacing the fuse:

110-120V~60Hz:  $\varnothing$ 5x20mm, T3.15AL/250V  
220-240V~50Hz:  $\varnothing$ 5x20mm, T1.6AL/250V

To access the fuse compartment, simply unplug the subwoofer from any power source, place a flat-head screw driver in the small notch and pry it open as illustrated below.

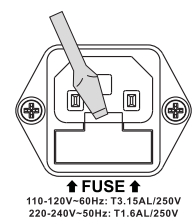



## Placing Your Subwoofer(s)

You often hear the term “subwoofers are non-directional.” This is not true. It is harder to choose subwoofer placement when low frequencies are crossed. The wider the room, the more directional the subwoofer. The easiest solution is to use two (2) subwoofers, feed a mono signal to both and place them in the front, one on the left and another on the right.

While having two (2) subs is better than one, the MONO signal that drives those subwoofers keeps them from projecting the three dimensional images in the sub-harmonics. Using two (2) subwoofers allows you to cross the subs up to 150Hz sound quality, imaging and staging. In some applications, you might have small front speakers or planar speakers. The two-front-subwoofer system is an excellent solution to planar speakers’ low frequency response early roll off from 150Hz on down. When placing these subwoofers in a close proximity to the stereo satellite, the subs will enhance low frequency extension. It will be better to have a stereo subwoofer to help in the lower bass notes and their placement.

Suppose you have only one (1) subwoofer in the room and it is placed on the right side of the room. If a bass guitar player was standing on the left side of the stage and played an EE note (42Hz), then the sub will also respond to that from the right side of the room and completely destroy the stage.

You will see illustrations showing the two (2) different suggested setups. In each of them, note the breakaway and the image separation represented by the black and gray arrows.

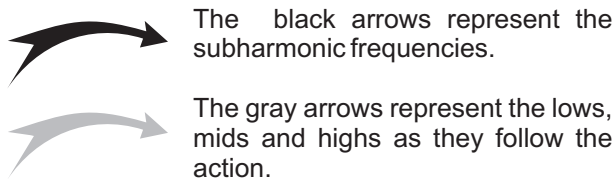

The best response is achieved when the subharmonic frequencies are dynamically synchronized with the rest of the audio system, the black and gray arrows are identical.

### Single Subwoofer Setup

This is a GOOD setup. The subharmonic frequencies (black arrow) always move towards the sub in the single sub setup while the lows, mids and highs (gray arrow) follow the action.

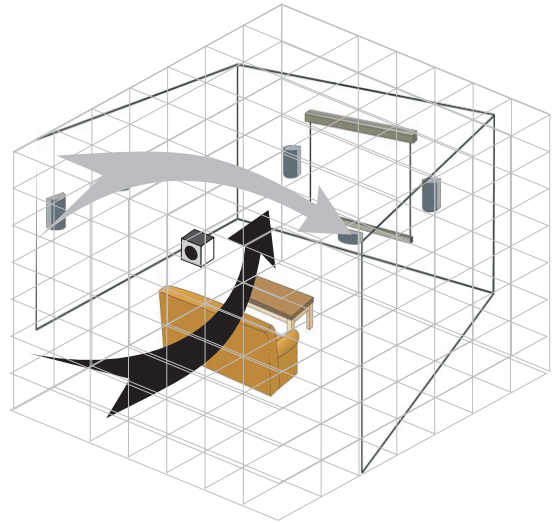

Placing the subwoofer in the corner of the room will produce a more boomy effect, often preferred for movies and sound tracks. For a music application, place the subwoofer as shown above or against the front wall, about a third of the room width.

### Dual Subwoofer Setup with Mono Signal

This is a BETTER setup. In a dual subwoofer setup, the subharmonic frequencies (black arrow) always move towards the middle of the room while the lows, mids and highs follow the action (gray arrow).

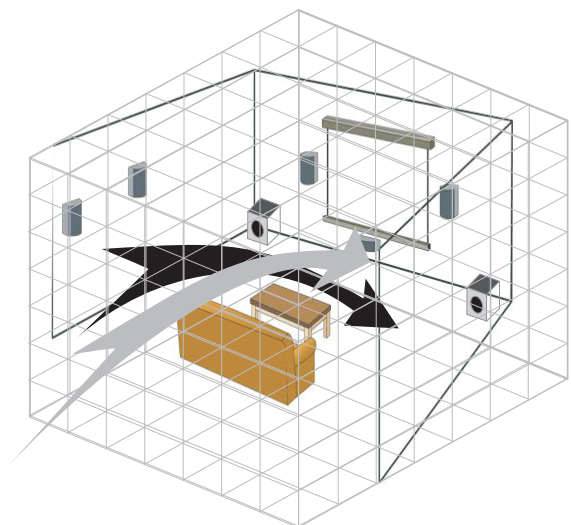

Notice the breakaway and image separation is less in this setup than the single subwoofer setup.

# Connecting Your Subwoofer(s)

## Low Level Setup - Single Sub

This is the best way to drive an audio signal into the MiniMe FF8v2. Today, most receivers/signal processors (5.1/6.1 and more advanced ones) come equipped with built-in pre-amplifier outputs (RCA) that include a subwoofer output. Generally, the SUB PRE OUT is in mono format. Connect the SUB PRE OUT from the processor/receiver to the MiniMe FF8v2's LOW LEVEL INPUT using a "Y" RCA cable.

We strongly recommend that you use the best available RCA connectors and cables. High quality cables are normally triple shielded and the connectors are gold plated with forceful grasping.

When using this connection, the MiniMe FF8v2 only receives bass signals from the source. Therefore, the crossover frequency should be set at max value.

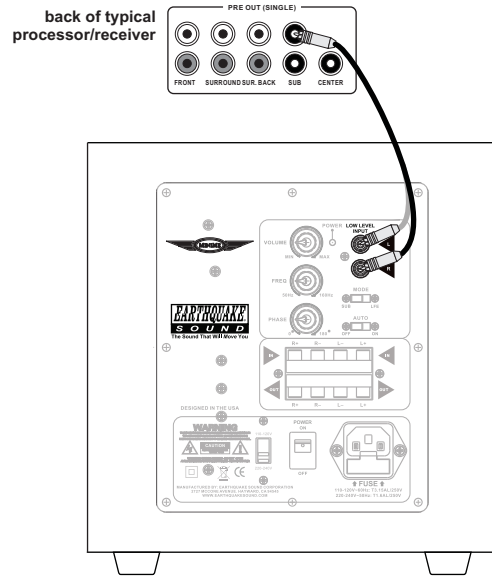

## Low Level Setup - Dual Sub

For a more realistic sound stage and greater theater experience, we suggest having two (2) subwoofers and running them in stereo.

Using a "Y" RCA cable, connect the SUB PRE OUT 1 of the receiver to the LOW LEVEL INPUT of the left side MiniMe FF8v2.

Using another "Y" RCA cable, connect the SUB PRE OUT 2 of the receiver to the LOW LEVEL INPUT of the right side MiniMe FF8v2.

In case the subwoofers become out of phase with the main front speakers, adjust the phase shift to correct the problem. Note that maximum bass is only achieved when the sub is in phase with the speakers in your system.

**NOTE:**  
DO NOT USE HIGH LEVEL AND LOW LEVEL INPUTS AT THE SAME TIME

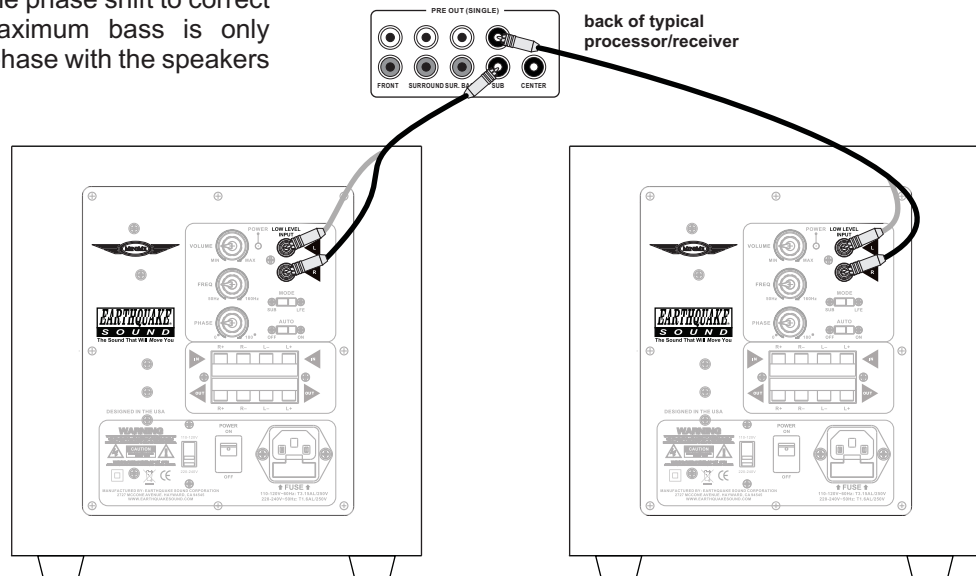

## High Level Setup - Single Sub

The MiniMe FF8<sub>v2</sub> has a high/speaker level input connection. This setup is a solution when you experience excessive noise or hum with the line level input.

Simply connect the speaker wire (up to 16-gauge) from the receiver's SPEAKER OUTPUTS to the MiniMe FF8<sub>v2</sub>'s SPEAKER.

Remember to always connect red-to-red and black-to-black when making connections between a receiver/processor to the subwoofer. You will notice a lack of bass from your subwoofer is you inadvertently reverse one of the connections (i.e. red-to-black).

In case the MiniMe FF8<sub>v2</sub> becomes out of phase with the main front speakers, adjust the phase shift to correct the problem. Note that maximum bass is only achieved when the sub is in phase with the speakers in your system.

**NOTE:**  
DO NOT USE HIGH LEVEL AND LOW LEVEL INPUTS AT THE SAME TIME

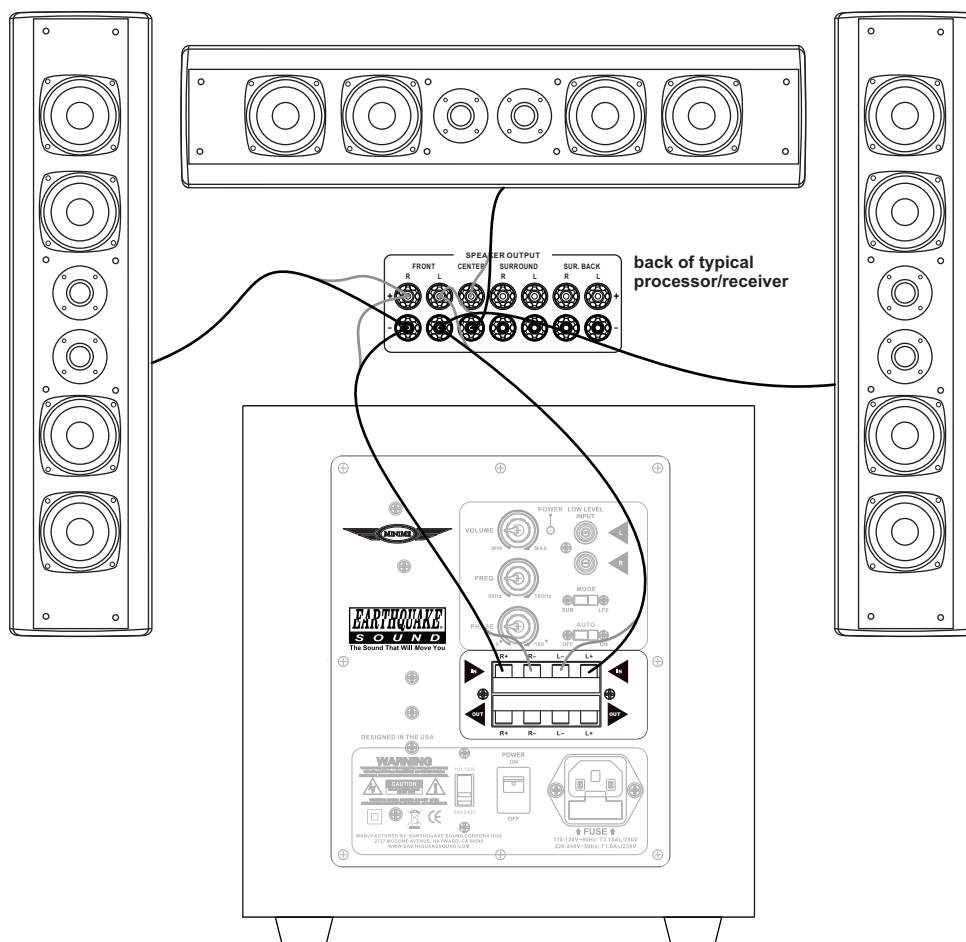

## Connecting Your Subwoofer(s) cont'd

### High Level - Single Sub + Satellite Setup

The MiniMe FF8<sub>v2</sub> has a high/speaker level output connection that can be used to drive the stereo front or rear speakers.

Using speaker wires (up to 16-gauge), simply connect the receiver's front speaker outputs to the MiniMe FF8<sub>v2</sub> speaker level inputs. Then using speaker wires, connect the MiniMe FF8<sub>v2</sub> speaker level outputs to the speakers.

Remember to always connect red-to-red and black-to-black when making connections between a receiver/processor to the subwoofer. You will notice a lack of bass from your subwoofer if you inadvertently reverse one of the connections (i.e. red-to-black).

In case the MiniMe FF8<sub>v2</sub> becomes out of phase with the main front speakers, adjust the phase shift to correct the problem. Note that maximum bass is only achieved when the sub is in phase with the speakers in your system.

**NOTE:**  
DO NOT USE HIGH LEVEL AND LOW LEVEL INPUTS AT THE SAME TIME

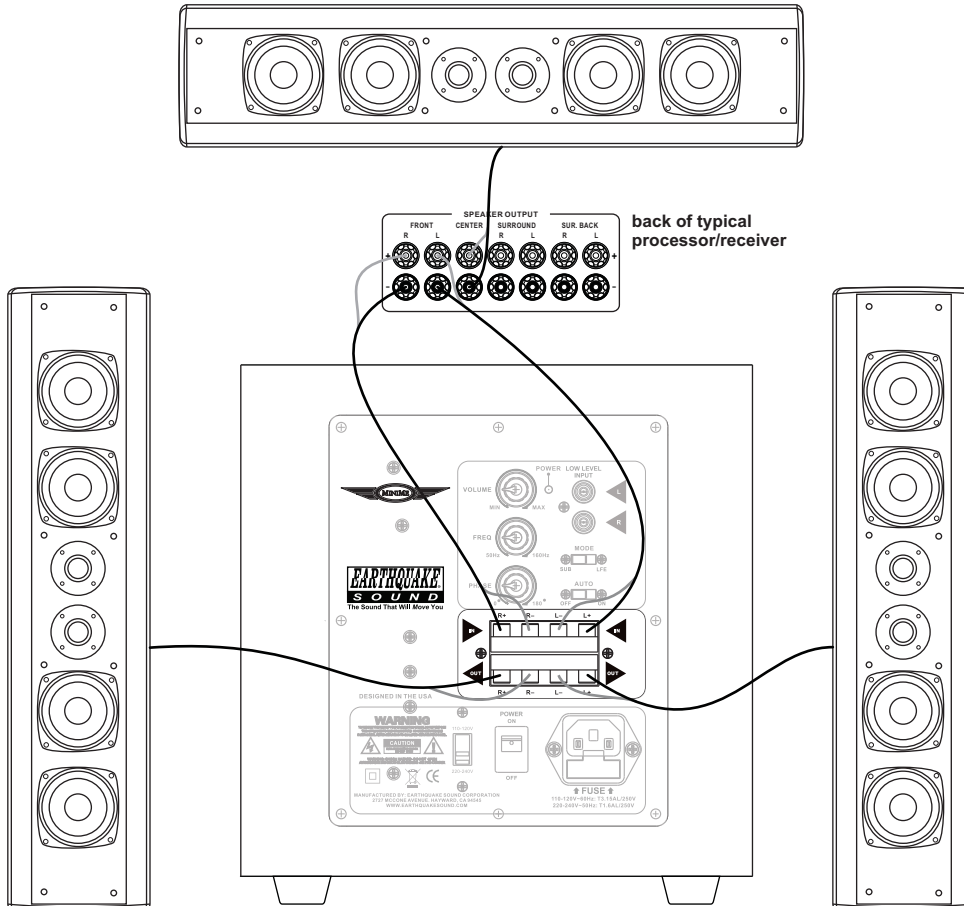

## High Level - Dual Sub

Connect the speaker wire (up to 16-gauge) from the receiver's RIGHT SPEAKER OUTPUTS to the MiniMe FF8v2's RIGHT SPEAKER INPUTS.

Then, connect the speaker wire from the receiver's LEFT SPEAKER OUTPUTS to the MiniMe FF8v2's LEFT SPEAKER INPUTS.

Remember to always connect red-to-red and black-to-black when making connections between a receiver/processor to the subwoofer. You will notice a lack of bass from your subwoofer if you inadvertently reverse one of the connections (i.e. red-to-black).

In case the subwoofers become out of phase with the main front speakers, adjust the phase shift to correct the problem. Note that maximum bass is only achieved when the sub is in phase with the speakers in your system.

**NOTE:**  
DO NOT USE HIGH LEVEL AND LOW LEVEL INPUTS AT THE SAME TIME

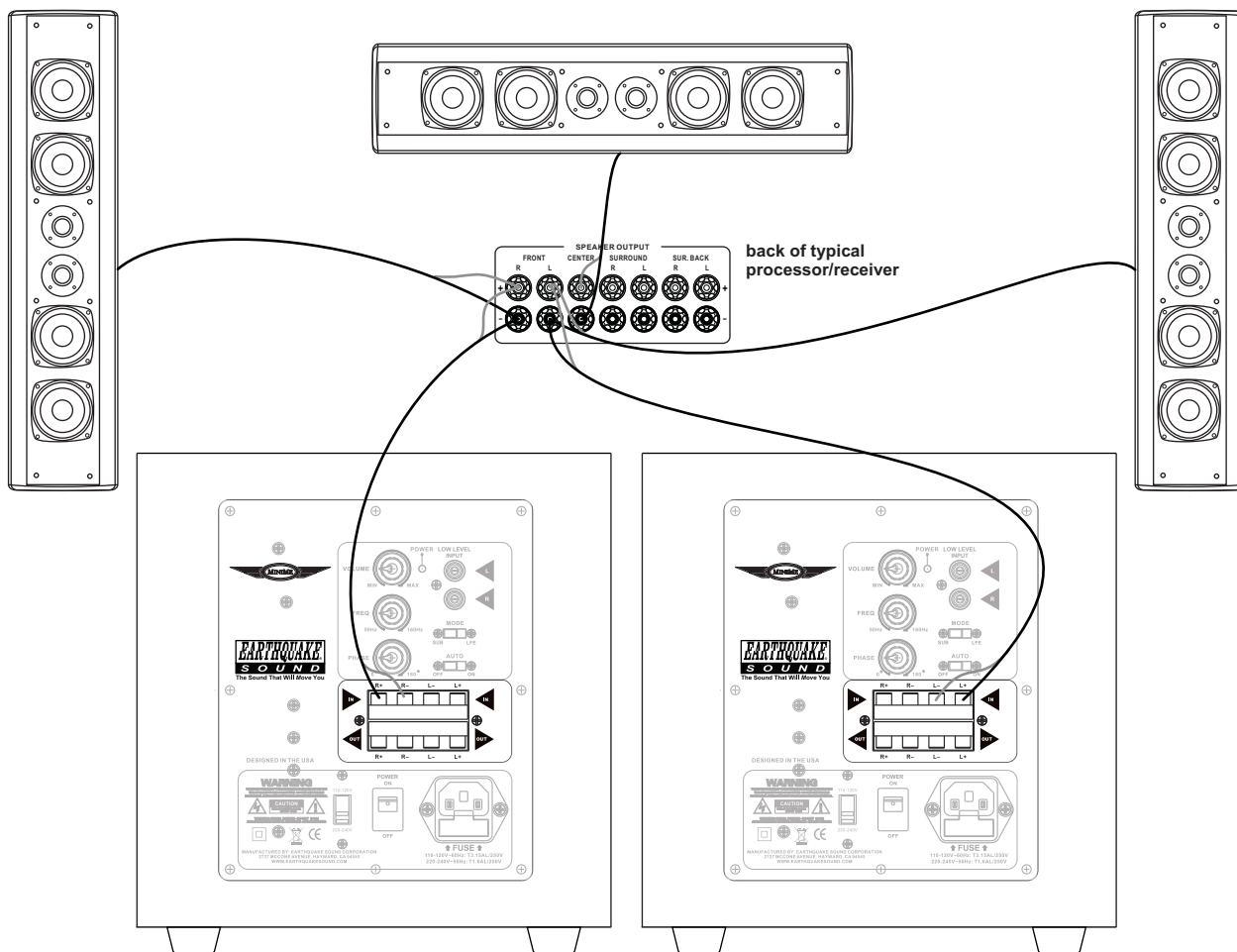



## Adjusting the controls

There are two main methods for adjusting the level/volume, crossover frequency and phase of the Earthquake MiniMe FF8v2 to match a system:

- Method 1 - Typical  
By listening and making adjustments to suit your preference.
- Method 2 - Laboratory  
By measuring the output and adjusting for a flat frequency response.

Satisfactory results can be achieved if you make the adjustments based simply on listening. This is Earthquake's preferred method as it allows the system to be voiced based on what sounds the best, whereas laboratory-flat frequency response can often be clinical and less than exciting.

The following procedures are for those who prefer a more methodical and scientific approach. You will need a test CD with low-frequency warble tones and an SPL meter.

### Step 1.

Disconnect the subwoofer and run the main speaker with a tone in its passband (80-100Hz). Measure the level.

### Step 2.

Disconnect the main speaker and reconnect the subwoofer. Set the subwoofer to its highest crossover frequency. Set the VOLUME of the subwoofer to give the same sound pressure level with the same tone you used in Step 1.

### Step 3.

With both the subwoofer and the main speaker connected, measure the level of the tones at the available frequencies. Because the crossover is set to high, you will have a peaked response. Adjust the crossover FREQ control to get the smoothest response.

### Step 4.

Use the phase control to make the response even smoother. It has its biggest effect at the crossover frequency. You can iterate between the crossover and the phase controls. Keep your hands off the VOLUME control as it was correctly set in Step 2.

### Step 5.

Listen to the subwoofer. Resist all temptation to turn up the VOLUME control. Play something with really deep bass to confirm that your subwoofer is working.

Use the following charts to record more desirable data from test results.

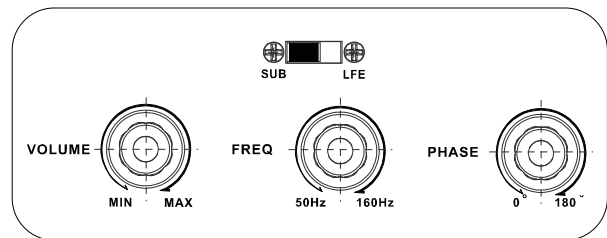
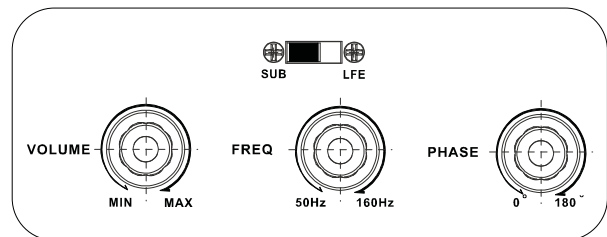
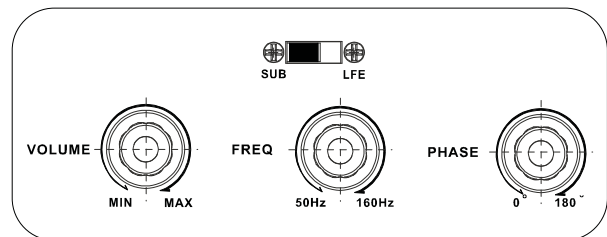
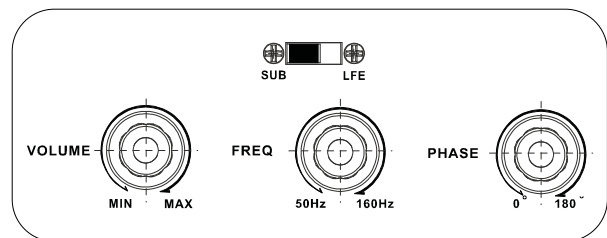
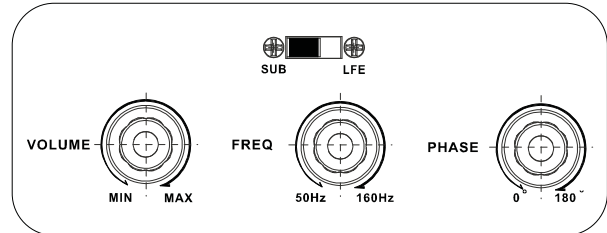

## MiniMe FF8v2 Subwoofer Dimensions and Specifications

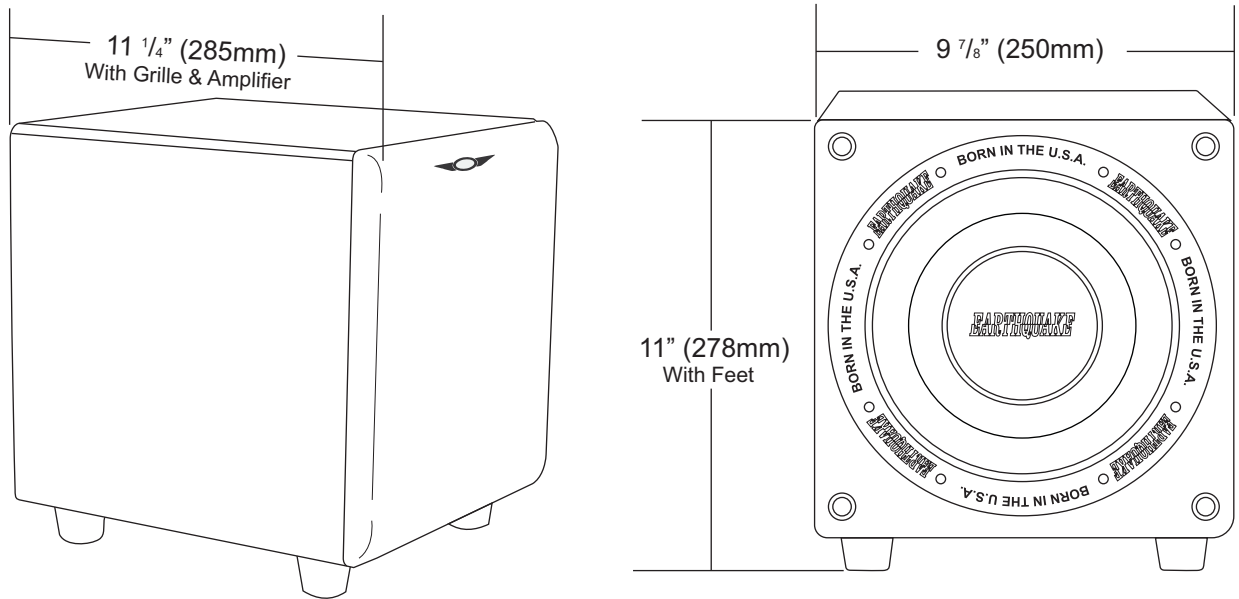

<b>Enclosure Type</b>	Sealed, Front Firing Enclosure
<b>Amplifier Power</b>	320 Watts MAX
<b>Driver</b>	8" Premium Extended Excursion Subwoofer
<b>Frequency Response</b>	25Hz - 160Hz
<b>Crossover Frequency</b>	50Hz - 160Hz
<b>Signal Sensing</b>	AUTO/ON/OFF
<b>Inputs/Outputs</b>	Low Level RCA & High Level Speaker Inputs High Level Speaker Outputs
<b>Additional Features</b>	0 - 180° Phase Adjustment 110V/220V AC Selector
<b>Fuse Ratings</b>	110-120V~60Hz: ø5x20mm, T3.15AL/250V 220-240V~50Hz: ø5x20mm, T1.6AL/250V
<b>Dimensions (H x W x D) including feet, grille &amp; amp</b>	11" x 9 7/8" x 11 1/4" (278mm x 250mm x 285mm)

## 5 Year Limited Warranty Information

Earthquake warrants the original purchaser that all Factory Sealed New Audio Products to be free from defects in material and workmanship under normal and proper use for a period of five (5) years from the date of purchase (as shown on the original sales receipt with serial number affixed/written on it).

The five (5) year limited warranty period is valid only if an authorized Earthquake dealer properly installs the product and the warranty registration card is properly filled out and sent to Earthquake Sound Corporation. If a non-authorized party installs the product, a ninety (90) day warranty period will be applied.

### **(A) Five (5) years limited warranty plan coverage guidelines:**

- **First year:** Earthquake pays for labor, parts, and ground freight (only in US mainland, not including Alaska and Hawaii. Shipping to us is not covered).
- **Second, third, fourth & fifth year:** Earthquake pays labor only. Customer must pay for parts and freight both ways.

### **(B) Warning:**

- Products (sent in for repair) that are tested by Earthquake technicians and deemed to have no problem will not be covered by the limited warranty. Customer will be charged a minimum of one (1) hour of labor (at ongoing rate) plus shipping charges back to customer.
- Each product sent in for repair must be packaged in its original packaging. Otherwise, **repackaging charges will apply in addition to the labor, parts and shipping charges.**

### **(C) Earthquake will repair or replace at our option all defective products/parts subject to the following provisions:**

- Defective products/parts have not been altered or repaired by anyone other than an Earthquake factory approved technician.
- Products/parts are not subjected to negligence, misuse, accident or damage by improper line voltage.
- Products/parts were used with incompatible products.
- The serial number or any part of the product has been altered, defaced or removed.
- Products/parts have been used in any way that is contrary to Earthquake's written instructions.

### **(D) Warranty Limitations:**

Warranty does not cover products that have been modified or abused, including but not limited to the following:

- Damages to speaker cabinet and cabinet finish due to misuse, abuse or improper use of cleaning materials/methods.
- Bent speaker frame, broken speaker connectors, hole(s) in speaker cone, hole(s) in surround &/ dust cap, and burnt speaker voice coil.
- Fading and/or deterioration of speaker components & finish due to improper exposure to elements.
- Bent amplifier casing, damaged finish on the casing due to abuse, misuse or improper use of cleaning material.
- Burnt tracers on PCB.
- Product/part damaged due to poor packaging or abusive shipping conditions.
- Subsequent damage to other products.

A warranty claim will not be valid if the warranty registration card is not properly filled & returned to Earthquake with a copy of the sales receipt.

### **(E) Service Request:**

To receive product service, contact Earthquake Service Department at (510) 732-1000 and request an RMA number (Return Material Authorization). Items shipped without a valid RMA number will be refused. Make sure you provide us with your complete/correct shipping address, a valid phone number, and a brief description of the problem you are experiencing with the product. In most cases, our technicians might be able to resolve the problem over the phone, thus eliminating the need to ship the product.

**(F) Shipping Instructions:**

Product(s) must be packaged in its original protective box(es) to minimize transport damage and prevent repackaging cost (at the ongoing rates). Shipper claims regarding items damaged in transit must be presented to carrier. Earthquake Sound Corporation reserves the right to refuse improperly packed product. A copy of the original sales receipt must accompany product returned to service. We encourage you to include with the package a written description of the problem. Ship product to:

Earthquake Sound Corp.  
2727 McCone Avenue, Hayward, CA 94545  
Tel: (510) 732-1000

You are responsible for the cost of shipping the product to Earthquake Sound Corporation.

**(G) Disputes Resolution:**

All disputes between clients and Earthquake Sound Corporation resulting from the five (5) year limited warranty policy must be resolved according to the laws & registration of the county of Alameda, California.

**For Your Records**

Date of Purchase: \_\_\_\_\_

Authorized Dealer/Installer Info:

Name: \_\_\_\_\_

Address: \_\_\_\_\_

\_\_\_\_\_

Phone: \_\_\_\_\_

Serial Number:

Notes

\_\_\_\_\_

\_\_\_\_\_

\_\_\_\_\_

\_\_\_\_\_

\_\_\_\_\_

\_\_\_\_\_

\_\_\_\_\_







**The Sound That Will *Move* You**

Earthquake Sound reserves the right to amend details of the specifications without notice.

© Copyright Earthquake Sound Corporation

Earthquake Sound Corporation

2727 McCone Avenue. Hayward CA, 94545. USA

Phone: 510-732-1000 Fax: 510-732-1095